













## URBAN ISLANDS UIS522

Banquette de 2 modules, longueur 1795mm, largeur 895mm

<b>Réalisation :</b>	Habillage en acier zingué et thermo laqué, plateau en bois exotique ou robinier
<b>Assise :</b>	Lames en bois de section rectangulaire avec disposition des lames à définir (voir tableau) Hauteurs : assise <b>A</b> /420mm ; assise <b>B</b> /690mm
<b>Habillage :</b>	Tôle d'acier cintrée découpée au laser avec renfort intérieur - Boulonnerie : Inox
<b>Finition :</b>	Une couche de peinture poudre polyester cuite au four – Peinture mate, grené fin
<b>Coloris standard:</b>	Peinture mate grené fin RAL 7016 Gris anthracite RAL 5002 Bleu outremer RAL 6005 Vert Mousse RAL 9006 Aluminium Blanc RAL 9005 Noir foncé RAL 9007 Aluminium gris Autres coloris RAL en option
<b>Poids :</b>	En jatoba : 153kg - en robinier : 143kg
<b>Fixation :</b>	Tiges filetées ou chevilles expansives (non fournies)
<b>Options :</b>	Différents assemblages et quantités de modules possibles (1, 2 ou 3 unités) Bois huilé Coloris hors standards Réalisation pour pose sans fixation au sol
<b>Références :</b>	
Bois exotique :	UIS522-11t / UIS522-22t / UIS522-33t / UIS522-12t / UIS522-32t
Robinié :	UIS522-11r / UIS522-22r / UIS522-33r / UIS522-12r / UIS522-32r



Variante	Orientation des lames	
	élément A	élément B
UIS522-11t UIS522-11r		
UIS522-22t UIS522-22r		
UIS522-33t UIS522-33r		
UIS522-12t UIS522-12r		
UIS522-32t UIS522-32r		
UIS522-23t UIS522-23r		

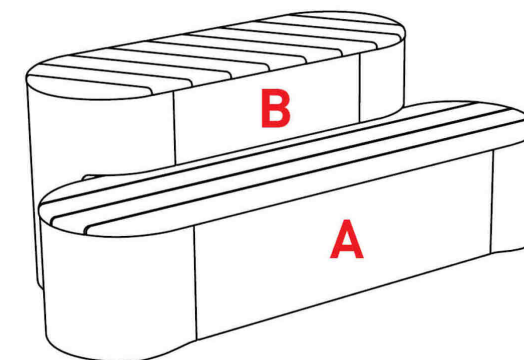



mmcitéfrance



16, place Théodore Fantin Latour  
56000 VANNES  
→ 00 33 (0) 297 639 431  
☎ 00 33 (0) 972 116 139  
[info@avenir-voirie.fr](mailto:info@avenir-voirie.fr)  
[www.avenir-voirie.fr](http://www.avenir-voirie.fr)

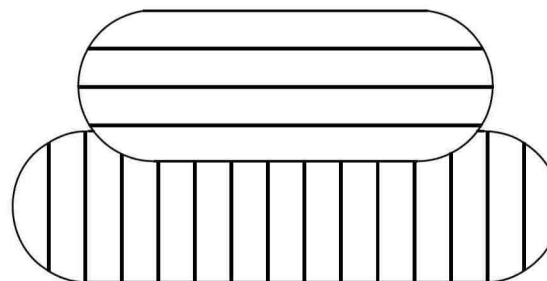
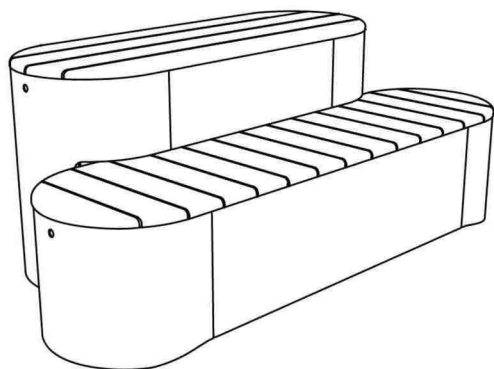
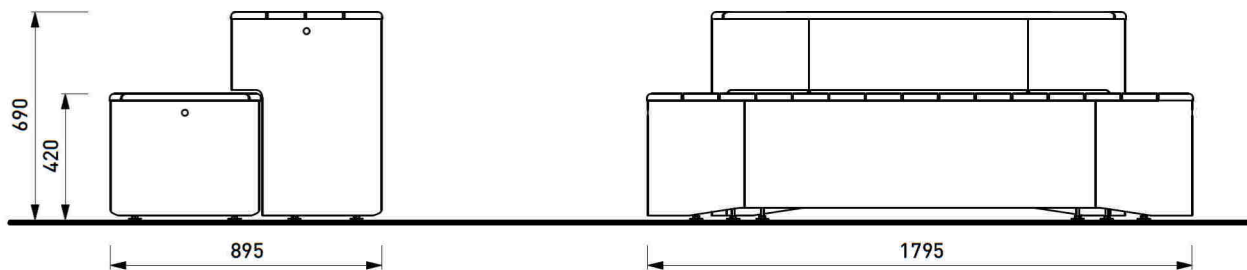

### UIS522-12 - URBAN ISLANDS