

## Banquette RIPPLE 350



**Description** : Banquette en béton hydrofugé.

### **Dimensions**

Longueur : 3500mm

Hauteur assise : 450mm

Largeur : 600mm

Poids : 870 kg

**Coloris standards** : Blanc, gris, marron, ocre, noir.

Autres couleurs sur demande avec plus-value.



AVENIR VOIRIE

+33 297 639 431  
info@avenir-voirie.fr

Référence : 24326AV

### Couleurs de finition

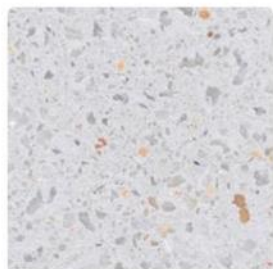

Blanc



Gris

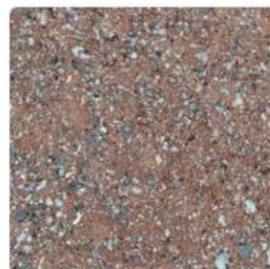

Marron



Ocre



Noir

### Optionnel

Fini hors moule

### Autres coloris (Consulter)

Consulter

Augmentation en pourcentage en fonction de la couleur. *Demander un devis.*

### Finitions de surface



Bronze



Corten



Golden



Noir graphite

Revêtements composés de liants qui intègrent des charges de métal concassé et donnent aux éléments urbains l'apparence réelle du métal ainsi que son oxydation et ne se détériorent pas avec le temps.

GEOMETRIA / GEOMETRY

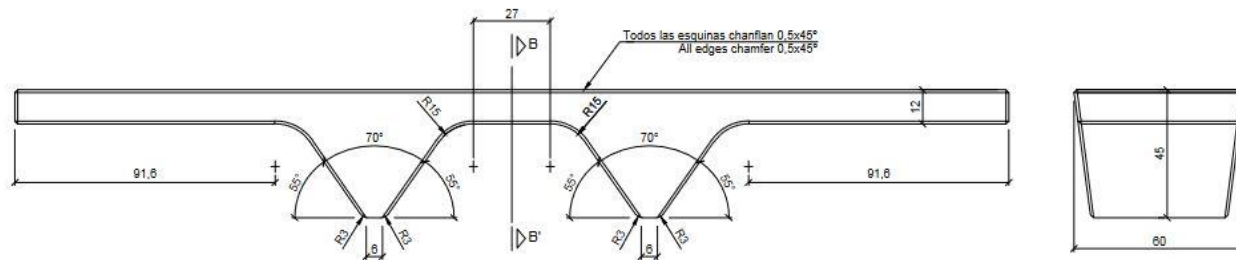

ALZADO / FRONT VIEW

PERFIL / RIGHT SIDE

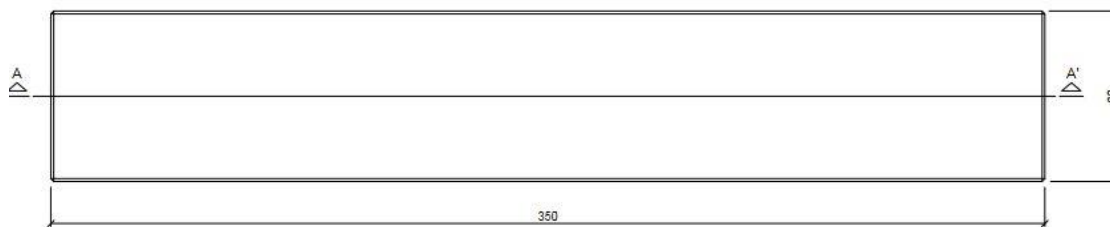

PLANTA / TOP VIEW

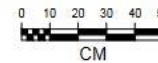

ESPECIFICACIONES / SPECIFICATIONS

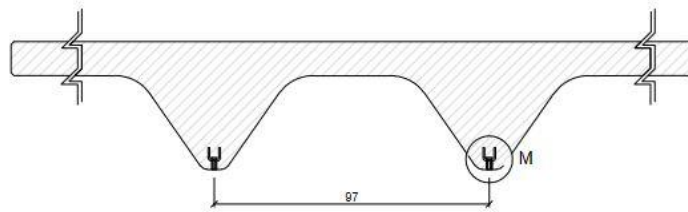

SECCIÓN A-A' / SECTION A-A'

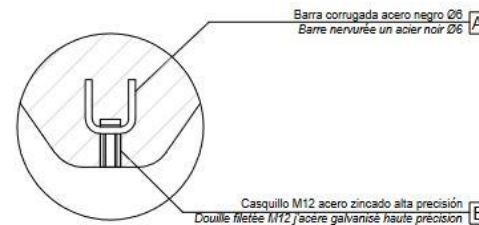

DETALLE M / DETALLE M

MANIPULACIÓN E INSTALACIÓN / HANDLING AND INSTALLATION

- 1 elevar y enroscar la varilla / lift and thread the rod
- 2 perforar agujero y verter resina epoxy / drill hole and pour resin epoxy

elevación / hoisting  
P= 870 Kg

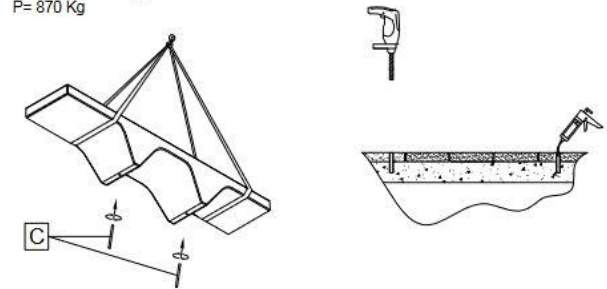

- 3 insertar la varilla en el agujero para instalar / insert metal rod in hole for install

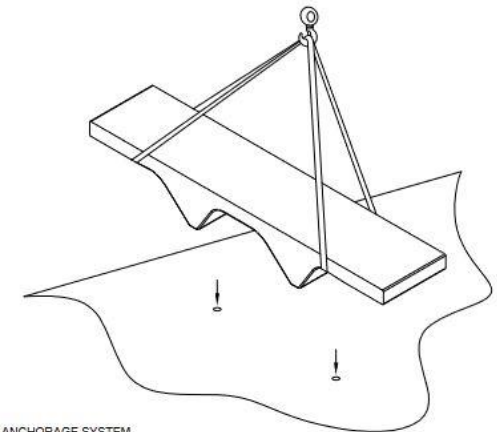

SISTEMA DE FIJACIÓN / ANCHORAGE SYSTEM

