

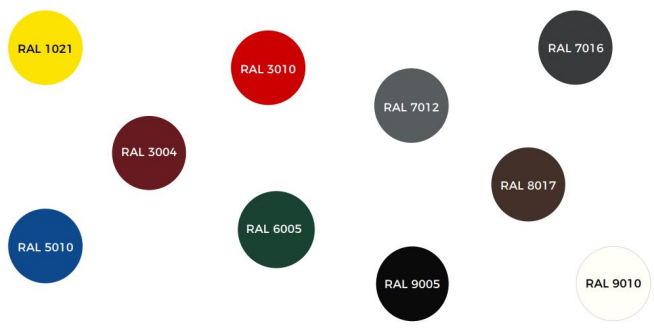

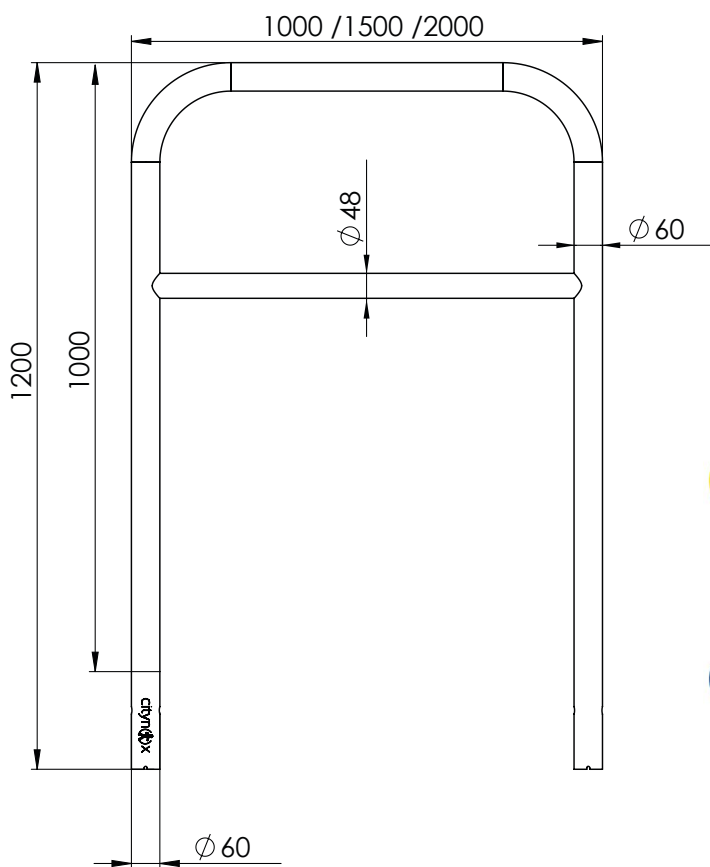

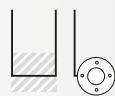

ARCEAUX DE PROTECTION RENFORCÉS



|  <p>FIXATIONS</p> <p>À sceller ou sur platine</p> |  <p>MATIÈRE</p> <p>Galvanisé ou galvanisé Peint</p> |  <p>DIAMÈTRES</p> <p>60</p> |  <p>HAUTEURS</p> <table border="1"> <tr> <th>HORS SOL</th> <th>HORS TOUT</th> </tr> <tr> <td>1000</td> <td>1200</td> </tr> </table> | HORS SOL | HORS TOUT | 1000 | 1200 |  <p>OPTION</p> <p>Autre RAL avec plus-value</p> |
|---------------------------------------------------------------------------------------------------------------------------------------------|-----------------------------------------------------------------------------------------------------------------------------------------------|-----------------------------------------------------------------------------------------------------------------------|--------------------------------------------------------------------------------------------------------------------------------------------------------------------------------------------------------------------------------|----------|-----------|------|------|---------------------------------------------------------------------------------------------------------------------------------------------|
| HORS SOL | HORS TOUT | | | | | | | |
| 1000 | 1200 | | | | | | | |