

## Banquette courbe

### DYNAMIC C-50

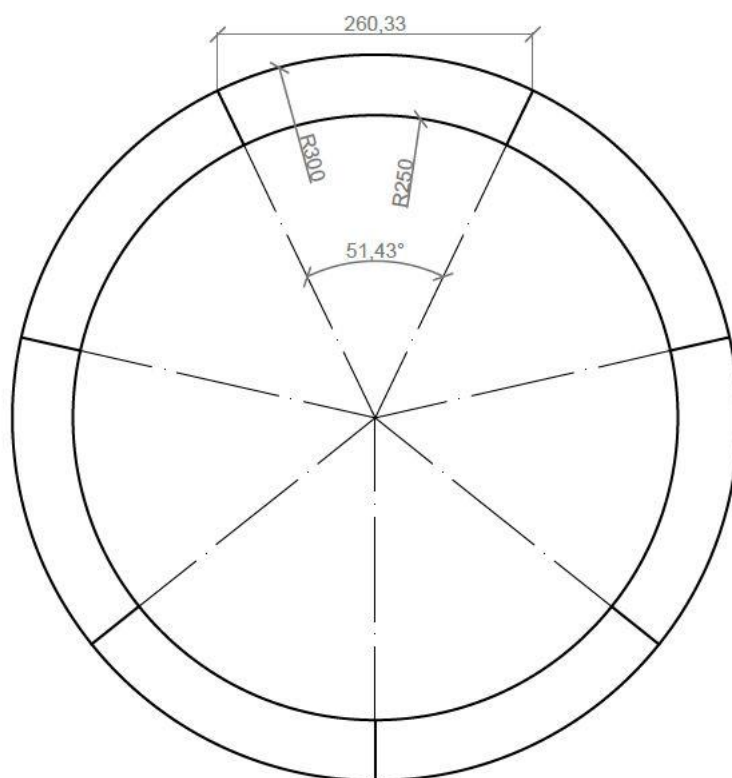

#### DESCRIPTION

Banquette publique DYNAMIC C50 en béton, rayon intérieur 2500mm

Assise en béton hydrofugé de couleur grise en version de base.

DIMENSIONS : Longueur 2603mm, largeur 500mm, hauteur 450mm, poids 1475kg. Angle 51,43°

RAYON INTERIEUR : 2500mm

RAYON EXTERIEUR : 3000mm

COLORIS : gris, blanc, ocre, noir, marron

OPTIONS : autres coloris, bande LED

## Couleurs de finition



Marron



Noir



Ocre



Gris

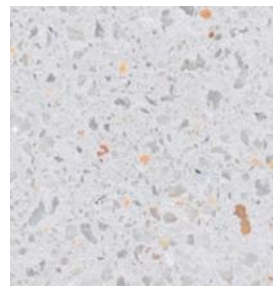

Blanc

## Finition de surface

Revêtements composés de liants qui intègrent des charges de métal concassé et donnent aux éléments urbains l'apparence réelle du métal ainsi que son oxydation et ne se détériorent pas avec le temps.

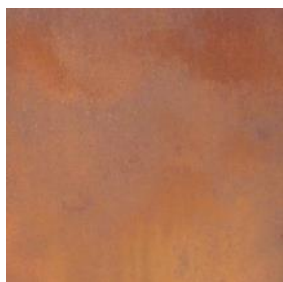

Corten



Noir graphite

## Couleurs en options



CARACTERISTICAS / FEATURES

**Material** precast concrete Petra 1  
**Finish** scaled and waterproofed  
**Dimensions** l.260,33, w.50, h. 45 cm  
**Colour** see colour catalogue  
**Fixing** resting on the ground or with epoxy resin  
**Weight** 1.475 Kg  
**Pallet** 270 x 90 cm



☎ 02 97 63 94 31  
 ✉ info@avenir-voirie.fr

DYNAMIC C-50

GEOMETRIA / GEOMETRY

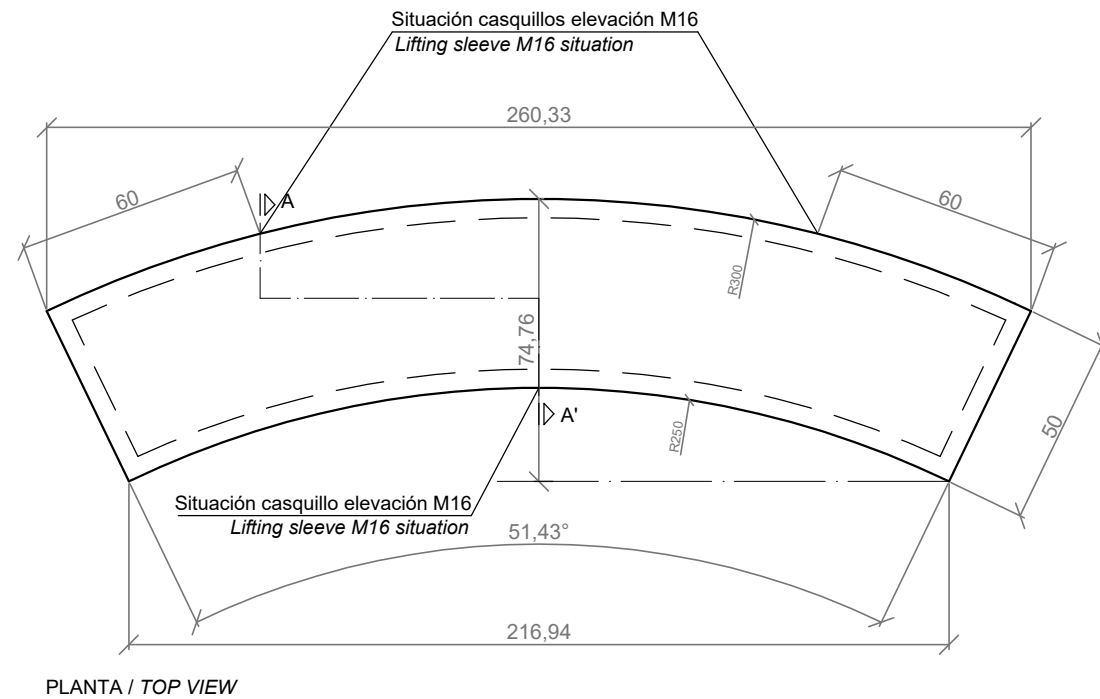
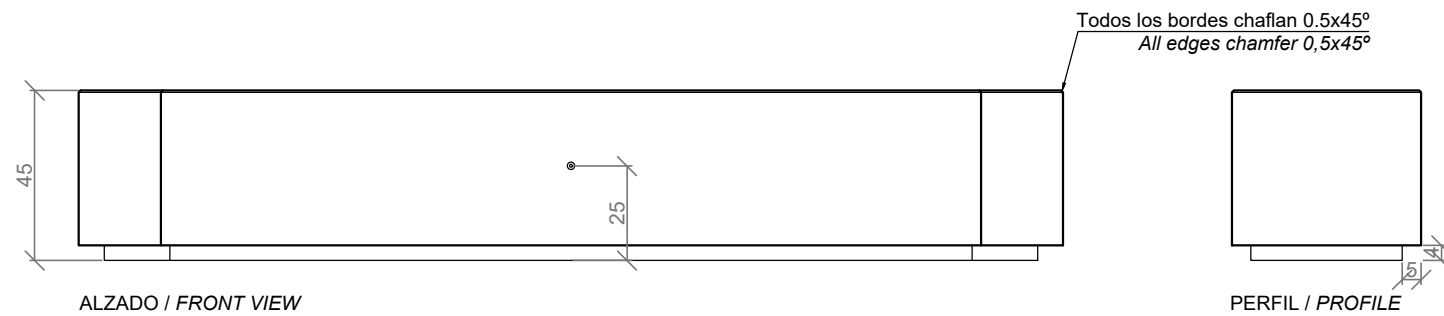

ESC. 1:20

MANIPULACIÓN E INSTALACIÓN / HANDLING AND INSTALLATION

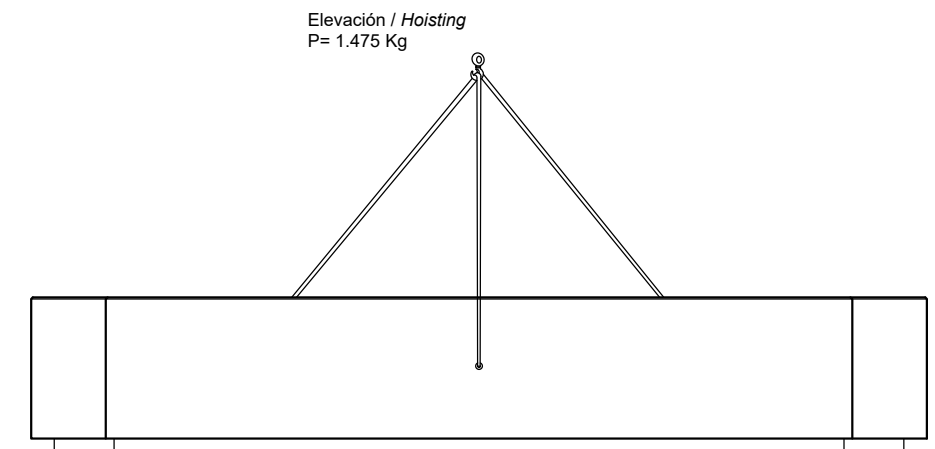

COMPOSICIÓN EN CÍRCULO

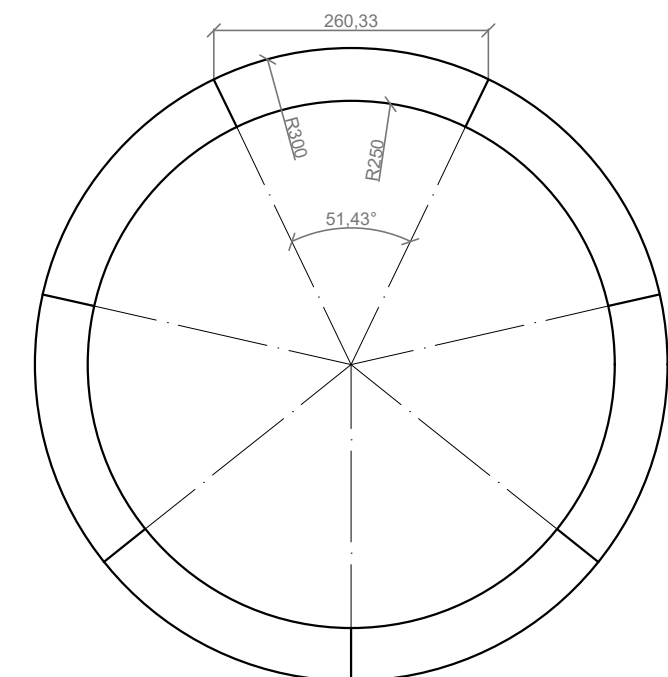

ESPECIFICACIONES / SPECIFICATIONS

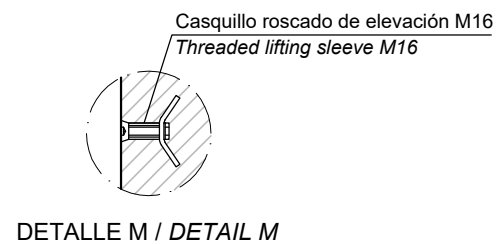
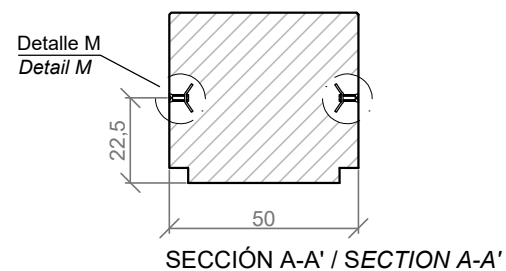

ESC. 1:20