





Banquette RADIANO

Banquette circulaire 1m72

- Bois :**
-  Bois tropical (LRA11b-200t)
 -  Chêne (LRA11b-200d)
 -  Épicéa (LRA11b-200s)
 -  Pin (LRA11b-200tw)



Description : Banquette circulaire. Structure en acier soudé thermo laqué ép. 5mm. Piétement en tôle d'acier thermo laqué ép. 8 mm. Les piétements sont attachés à la structure par trois vis M8. L'assise est composée de 16 lames de longueurs 440 mm en bois de : Chêne, Épicéa, Pin thermo traité ou Bois Tropical. Les planches de bois sont assemblées à la structure par des boulons en acier inoxydable.

Dimensions

Hauteur : 435 mm

Largeur : 440 mm

Longueur : 1723 mm

Coloris standards : RAL 7016 (gris anthracite), RAL 9005 (noir jet), RAL 9006 (aluminium blanc), RAL 9007 (aluminium gris), RAL 9003 (blanc), RAL 3003 (rouge), RAL 6021 (vert).

Traitement du bois : Épicéa imprégné avec deux couches et laqué avec un mélange d'eau et de cire d'abeille. Bois tropical avec de l'huile de teck. Chêne teck avec traitement de surface. Pin traité avec ThermoWood® contient une protection anti-uv.

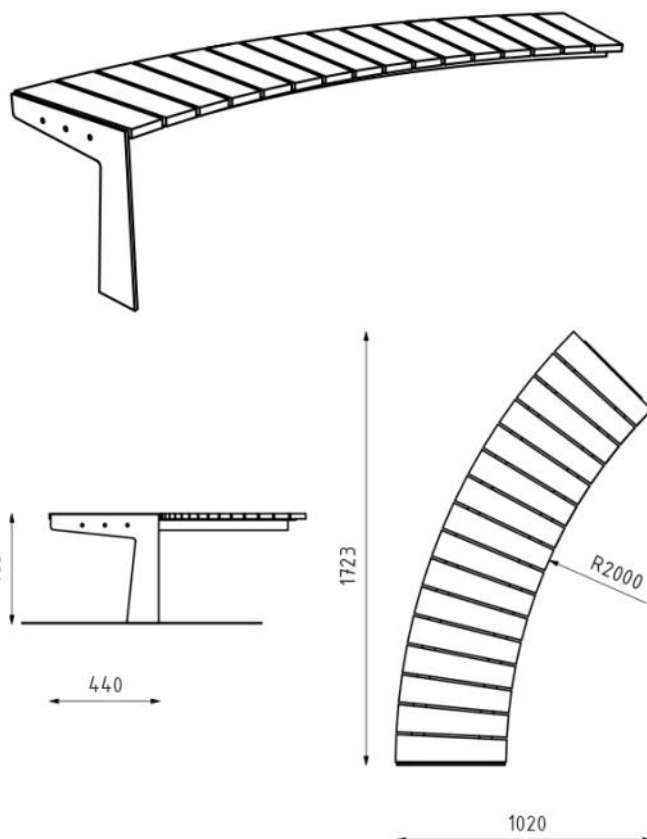

MÉTAL



RAL 7016



RAL 9005



RAL 9006



RAL 9007

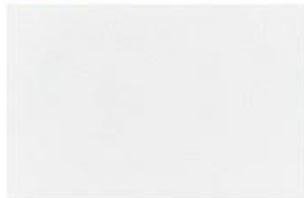

RAL 9003



RAL 3003



RAL 6021



CORTEN



ZINC



INOX



ALUMINUM

BOIS



BOIS TROPICAL



PIN



EPICÉA



ACACIA



CHÊNE